



-----FIREPLACES-----



**INSTALLATION INSTRUCTIONS
PHOENIX HORIZON NATURAL DRAFT
THREE SIDED 400**

Installation Instructions Phoenix Horizon Three Sided

Natural Draft Oxygen Depletion Ignition approved for the following models

SUITABLE GAS BURNER OPTION

THREE SIDED MODELS

1100 Three-sided	1000 Type 1 Phoenix Burner
1500 Three-sided	1400 Type 1 Phoenix Burner
2000 Three-sided	1800 Type 1 Phoenix Burner

Model Type 1: Natural Draft Oxygen Depletion Ignition Gas Fireplace

DATA PLATE: Refer to data plate details in this Instruction booklet in respect to gas pressure, consumption and gas type, Natural gas only.

Data Plate is located under the gas burner and is accessed by lifting front access panel or removing base plate.

Location Requirements

Natural draft oxygen depletion ignition fireplaces are designed to be installed as a complete fireplace system. The firebox incorporates a gas burner with electronic ignition and spiggot for attaching a flue. The flue needs to run vertically and exit above the roof line. 45 degrees bends can be utilised. All Australian requirements for flues are to be observed when installing.

Ventilation Requirements:

Rooms with gas open fireplaces require as per clause 6.10.9.5 in AS/NZS5601.1:2022, one or more ventilation openings with a combined free ventilation area of not less than the equivalent cross section area of the flue cowl shall be provided for each decorative flame effect fire, and calculations based on clause 6.4.4

“THIS APPLIANCE REQUIRES FRESH AIR TO OPERATE SAFELY. THE ROOM WHERE THIS APPLIANCE IS INSTALLED MUST HAVE PERMANENT VENTILATION FROM OUTDOORS, IN ACCORDANCE WITH THE VENTILATION REQUIREMENTS OF AS/NZS 5601”

NOTE: The chimney in which the appliance is installed is not to be considered as a ventilation opening.

Installation Instructions Phoenix Horizon Three Sided

Before Installation

The Natural Draft Oxygen Depletion Ignition (N.D.O.D.I.) flue system shall be installed by authorized personnel in accordance with the manufacturer's installation instructions, local gas fitting regulations, municipal building codes, electrical wiring regulations, and any other statutory regulations. Contact your local building authorities about restrictions and installation inspections that may be required. If in doubt, contact your local dealer or Kemlan's Head office.

IMPORTANT AUSTRALIAN CODES:

- Australian Standards AS 5601 Gas Installation
- Australian Standards AS 3000 Electrical

Important Safety Notes

- Comply with all instructions in manual including clearances to combustible material.
- Do not operate without fully assembling all components.
- All open gas fires require ventilation in the room.
- Do not connect to any other air distribution duct or system.
- An Australian approved cowl is required at flue terminal. Cowls are made from ss304 2b materials
- Refer to the table below for flue diameter and flue cowl size.
- Air movement of systems- A decorative gas log fire must not be installed where the operation of any ventilation system, fan or air blower could in any circumstances cause the air pressure to be less than atmospheric at the appliance.
- Do not block or restrict chimney.
- After installing appliance check that the flue draws well with smoke pellet.
- Kemlan recommends that all gas fires be serviced every year.
- All gas units must be fitted by a licensed gas fitter.
- It is the responsibility of the gas fitter to follow the regulations set out in the Gas Code that dictate the procedures to follow when installing a gas appliance, particularly regarding gas pipe sizing and checking of pressures.
- All Horizon gas appliances range are recommended to use Kemlan manufactured double flue system. Sizes depend on the appliance/s purchased. The active flue is manufactured using .55mm ss304 2B and the outer flues are manufactured using .55mm galvanised steel.

Rear clearances to combustible material
Edge: 25mm

Installation

- 1 The N.D.O.D.I. system is supplied with all required electrical fittings. Work needs to be undertaken by a licensed electrician if extending wiring. Wiring requires clearance of minimum 100mm to flues and fireplace body due to heat. See Wiring diagram page 15. The wiring must be positively secured away from the heat source.
- 2 An isolation switch needs to be provided if connecting within the fireplace framework.
- 3 Discard all packaging and transport materials.
- 4 Build a frame to the specifications provided.
Note: 80mm clearance above the fireplace and 5mm to the front surface of firebox.
- 5 Unit located on 9mm fiber cement sheeting.
- 6 Unit and flues to be installed prior to plastering.
- 7 Gas line run to the desired position prior to plastering.
- 8 A minimum height of 150mm from floor needs to be available for use.
- 9 Clearance of 25mm to the vertical flue.
- 10 Allow for a minimum flue height of 4m.
- 11 All flue components are to be riveted together.
- 12 Rooms with Gas Open Fires require fresh air vents of 400sq centimetres for each Decorative Gas, Coal Fire.
- 13 When using Type 1 appliances into existing masonry chimneys, the minimum required height is 400mm x 400mm depth. The width should accommodate the burner with an additional 50mm clearance on each side. The maximum height is 400mm above the burner tray. Ensure that the chimney is drawing correctly and there is no spillage.
It is also recommended that a secondary guard is installed into the masonry chimney in accordance with AS/NZS 2286.

WARNING:

Do not use an unlined masonry chimney as the flue for this appliance

WARNING: ALTERATIONS TO THE ELECTRICAL SWITCH OR COMPONENTS MUST BE CARRIED OUT BY A LICENCED ELECTRICIAN AND BE DONE IN ACCORDANCE WITH AS3000.

Ventilation Requirements:

Rooms with gas open fireplaces require as per clause 6.10.9.5 in AS/NZS5601.1:2013, one or more ventilation openings with a combined free ventilation area of not less than the equivalent cross section area of the flue cowl shall be provided for each decorative flame effect fire, and calculations based on clause 6.4.4

“THIS APPLIANCE REQUIRES FRESH AIR TO OPERATE SAFELY. THE ROOM WHERE THIS APPLIANCE IS INSTALLED MUST HAVE PERMANENT VENTILATION FROM OUTDOORS, IN ACCORDANCE WITH THE VENTILATION REQUIREMENTS OF AS/NZS 5601”

Installation Instructions Phoenix Horizon Three Sided

ASSEMBLY REQUIREMENTS : THREE SIDED MODEL SHOWN

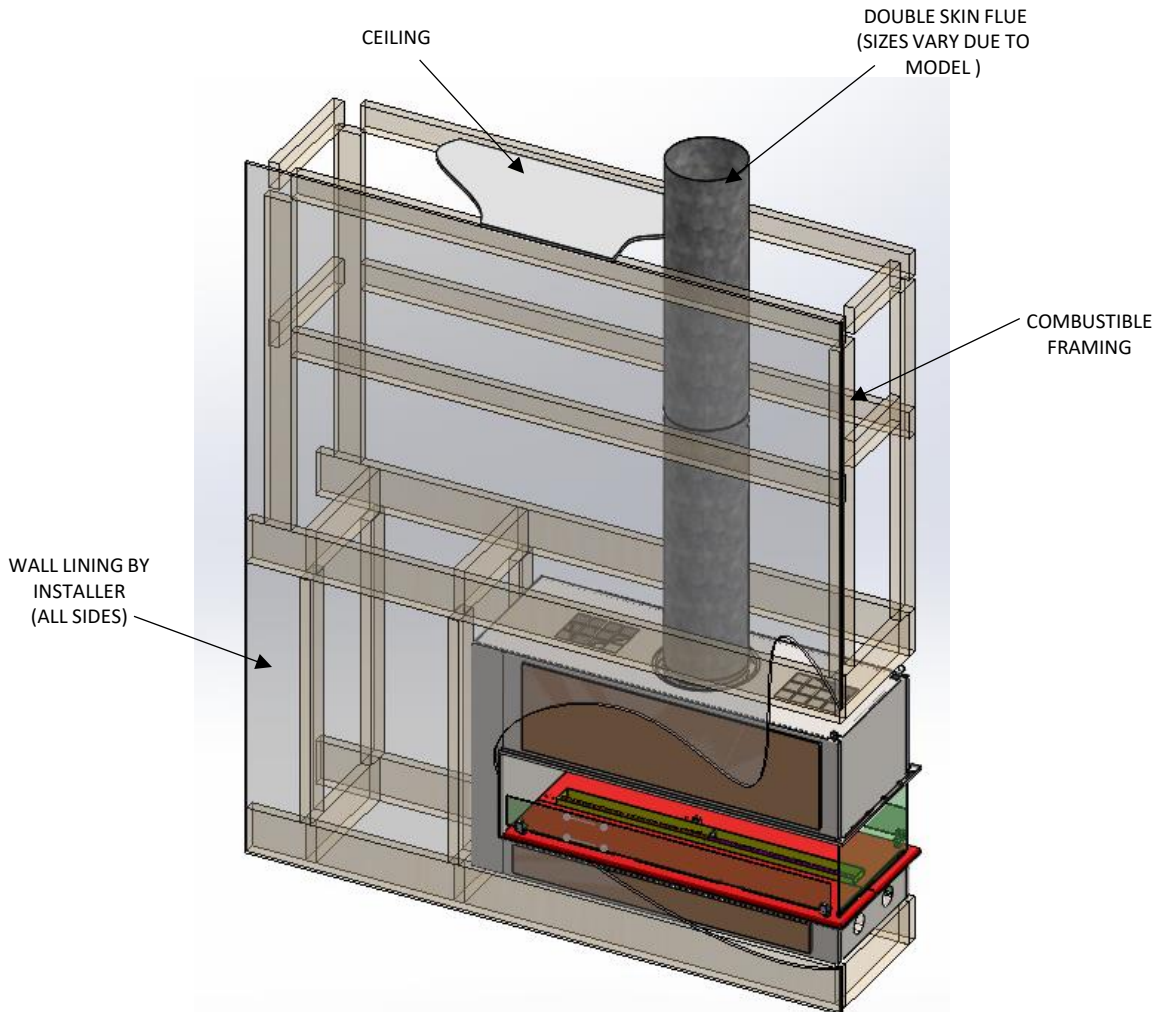

Ventilation Requirements:

Rooms with gas open fireplaces require fresh air vents according to clause 6.4.4 in AS/NZS5601. Ventilation size can be altered depending on the appliances M_j usage Vs the total room size the appliance is situated m^3 , this will be determined by a licensed gas fitter.

NOTE: The chimney in which the appliance is installed is not to be considered as a ventilation opening.

Installation Instructions Phoenix Horizon Three Sided

HORIZON THREE SIDED :

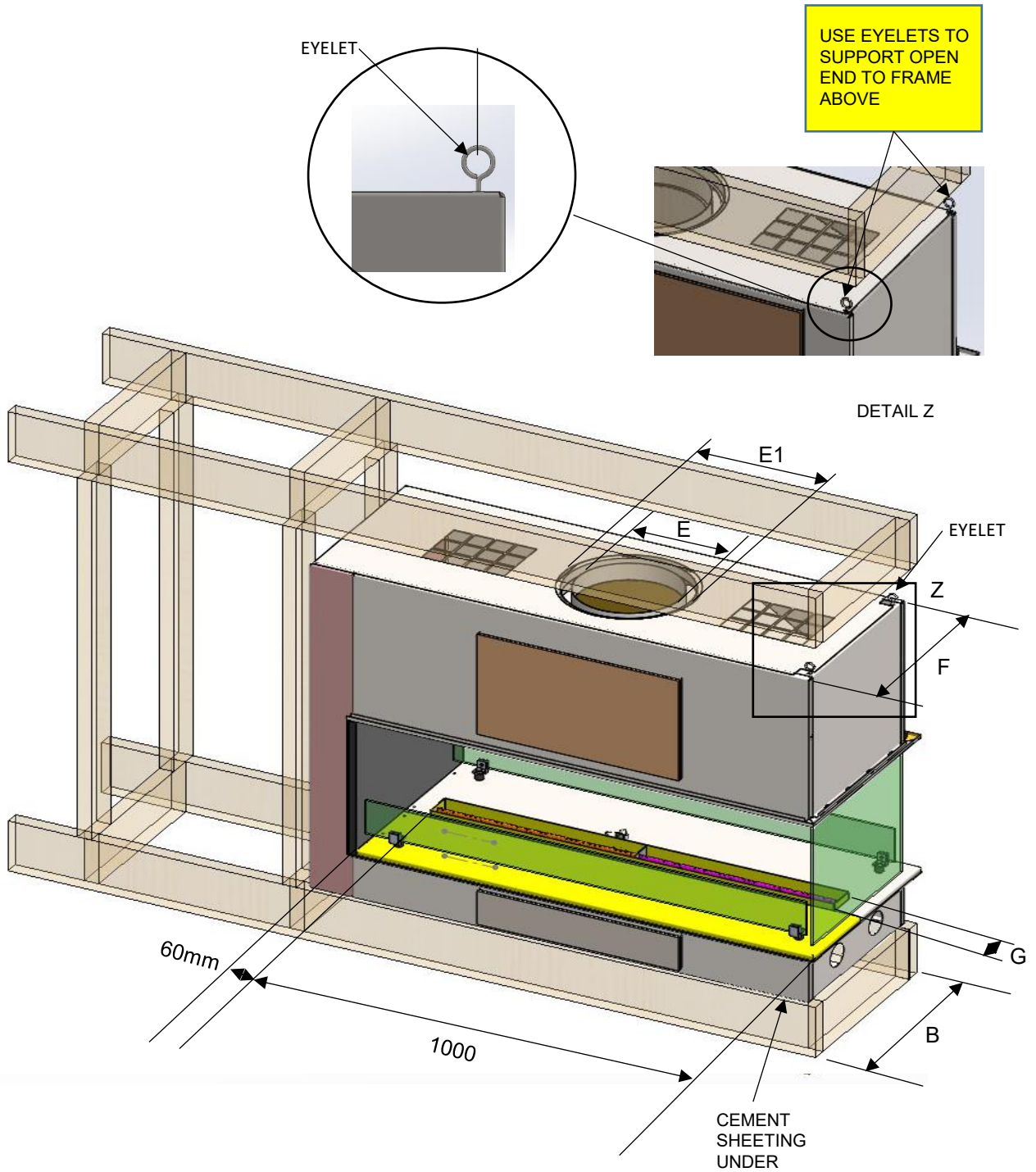

THREE SIDED PHOENIX	A	B*	C	D	E	E1	F	G	H	I
1100 LOW LINE	1264	480*	972	423	10"	12"	450	69	27	12
1500 LOW LINE	1685	490*	1117	568	12"	14"	435	69	27	12
2000 LOW LINE	2174	490*	1306	757	12"	14"	435	69	27	12

* NOT INCLUDING 10MM FIBRE CEMENT SHEETING

Installation Instructions Phoenix Horizon Three Sided

Measurement and Specification

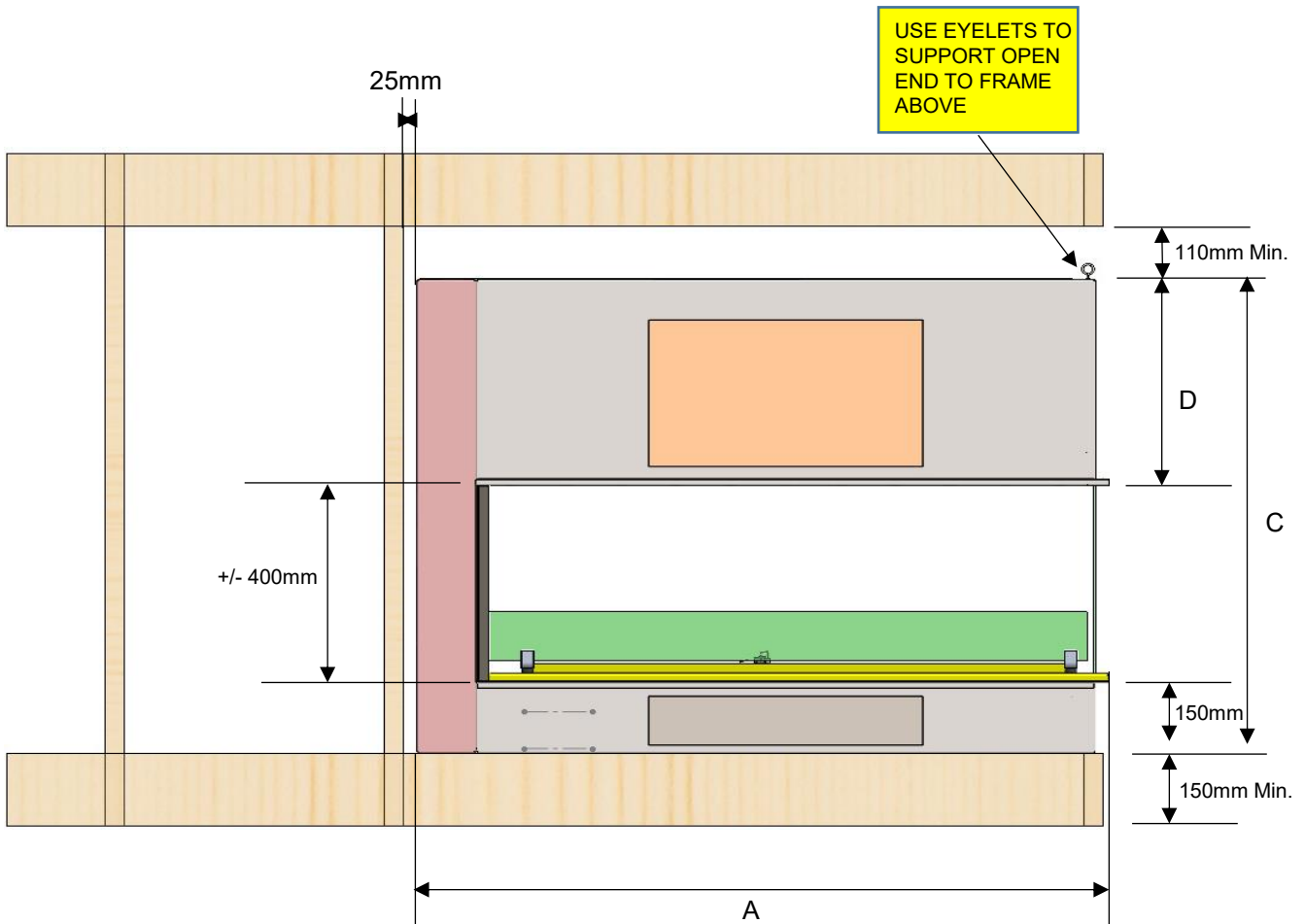
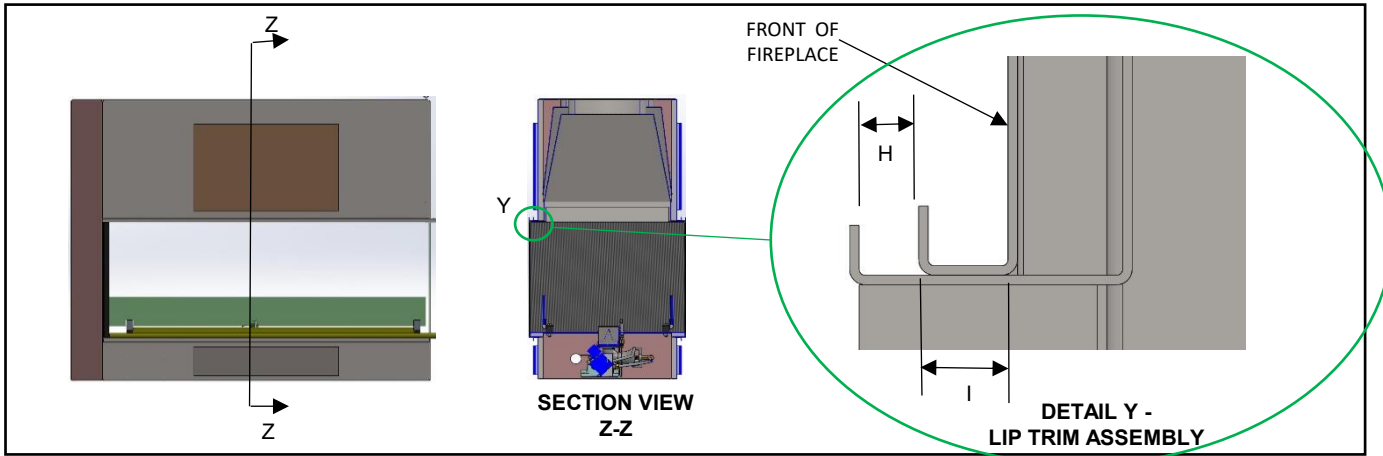

THREE SIDED PHOENIX	A	B*	C	D	E	E1	F	G	H	I
1100 LOW LINE	1264	480*	972	423	10"	12"	450	69	27	12
1500 LOW LINE	1685	490*	1117	568	12"	14"	435	69	27	12
2000 LOW LINE	2174	490*	1306	757	12"	14"	435	69	27	12

* LIP TRIM TO LIP TRIM - NOT INCLUDING 10MM FIBRE CEMENT SHEETING

Installation Instructions Phoenix Horizon Three Sided

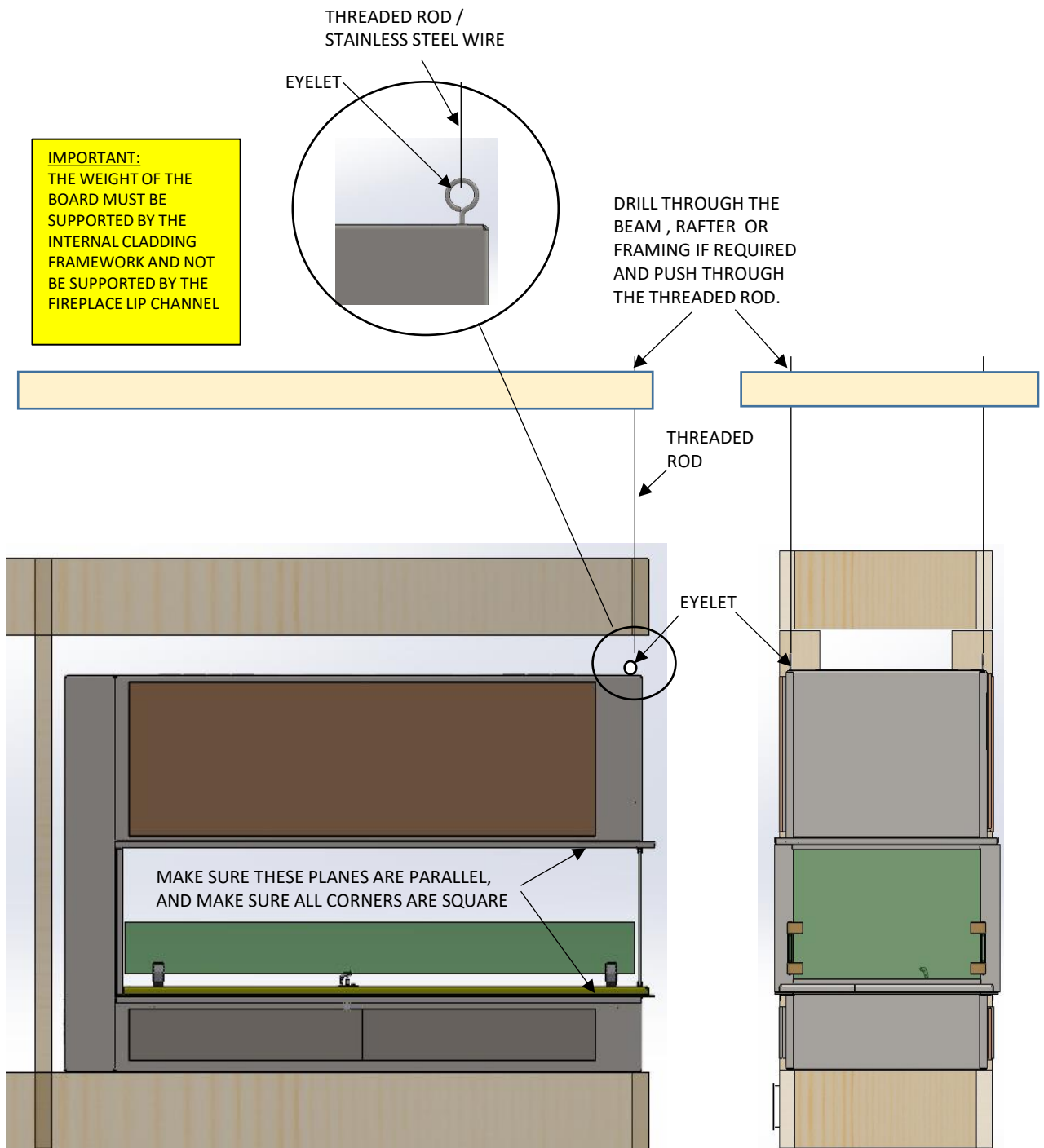

- Eyelets on the unit are supplied for attaching a turn buckle system, 6-8mm threaded rod is required with a nut and washer either side of a sufficient supporting roof member. Alternatively, a stainless steel wire with a minimum 1mm diameter or heavier and a minimum break load of 130kg can also be used.
- Once hooks have been attached to the eyelets the turn buckle can then be simply wound up to take the tension.
- Tighten the turn buckle until both the top and bottom glass runners are parallel.
- Removable glass panel can now be placed in position allowing an even gap between glass and underside of channel.

Installation Instructions Phoenix Horizon Three Sided

SECTIONS

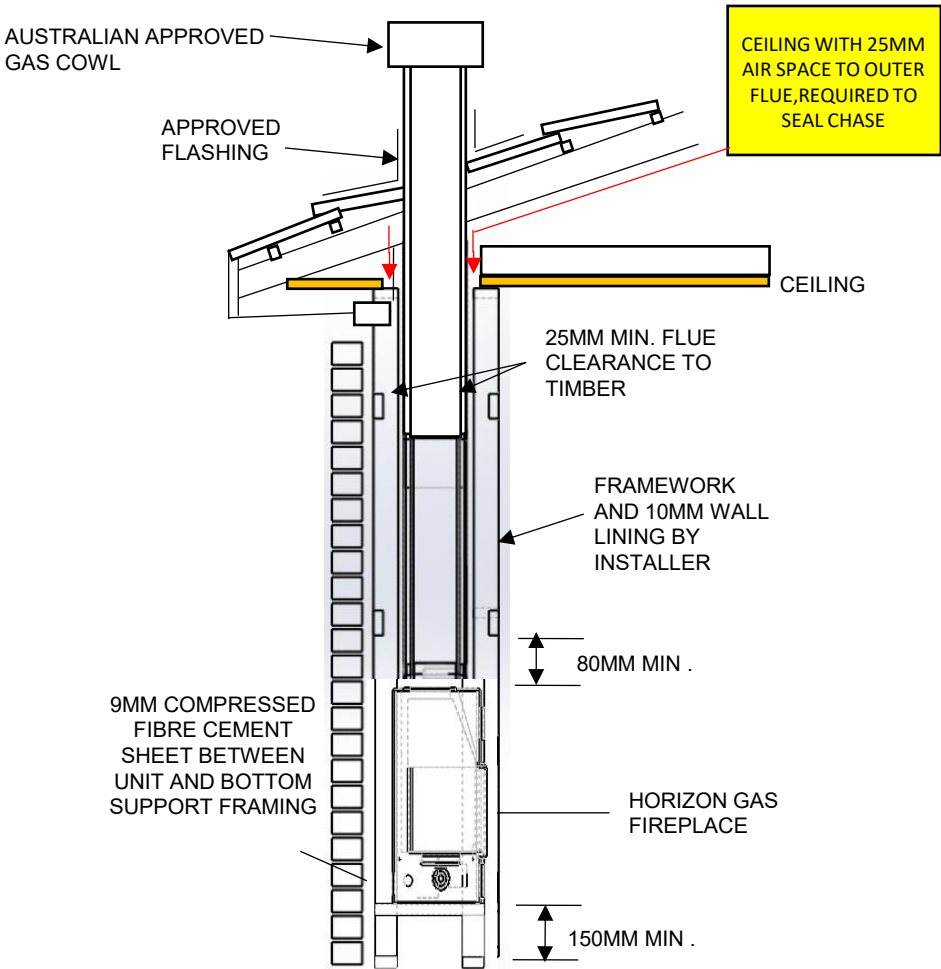

Installation Instructions Phoenix Horizon Three Sided

SERIAL NO. XXXX

KEMLAN INDUSTRIES

13 FRENCH AVENUE

IAPMO NO. GMK10737

BRENDALE QLD 4500

MODEL:	MODEL NO.	GAS TYPE	BURNER	GAS CONS.	INJECTOR	T.P.P.
HORIZON RANGE			OPTION	MJ / HR	SIZE	K/PA
				NAT GAS	NAT GAS	NAT GAS
<u>SINGLE SIDED:</u>						
1100PHOEN	PHOENHOR1100	NAT GAS	1000	42	2.2 x 2	0.9
1500PHOEN	PHOENHOR1500	NAT GAS	1400	65	2.2 x 3	0.9
2000PHOEN	PHOENHOR2000	NAT GAS	1800	68	2.2 x 3	0.9
<u>CANTILEVER:</u>						
1100PHOEN	PHOENHORC1100	NAT GAS	1000	42	2.2 x 2	0.9
1500PHOEN	PHOENHORC1500	NAT GAS	1400	65	2.2 x 3	0.9
2000PHOEN	PHOENHORC2000	NAT GAS	1800	68	4	1
<u>DOUBLE SIDED:</u>						
1100 Low Line	PHOENHORD1100	NAT GAS	1000	42	2.2 x 2	0.9
1500 Low Line	PHOENHORD1500	NAT GAS	1400	65	2.2 x 3	0.9
2000 Low Line	PHOENHORD2000	NAT GAS	2000	68	2.2 x 3	0.9

* THIS APPLIANCE CONSISTS OF A COMPLETE ASSEMBLY WHICH INCLUDES A FIREBOX AND FABRICATED FLUE SYSTEM. PLEASE REFER TO INSTRUCTIONS FOR CLEARANCES TO COMBUSTIBLE MATERIAL, FLUE SIZES AND METHOD OF INSTALLATION.

* PRIMARILY A DECORATIVE AND NOT A HEATING APPLIANCE.

AFTER INSTALLING APPLIANCE CHECK THAT CHIMNEY DRAWS PROPERLY.

Installation Instructions Phoenix Horizon Three Sided

Gas Installation

- 1 Check unit is suitable for intended gas supply.
- 2 Note position on gas appliance on drawing specification on right hand side of appliance.
- 3 A gas cock has to be fitted prior to gas burner to allow unit to be removed for servicing.
- 4 If material has been installed around firebox and access panel below is not accessible the top plate can be removed to gain access by removing four screws and lifting out top plate.
- 5 Connection is half inch BSP fitting. Cut and deburr both ends of pipe. Fit end to gas supply point and turn on for approximately 5 seconds to clear dirt and grit out of pipe. Connect into gas valve.
- 6 Turn on the gas and check all connections for leaks using approved method for testing. Fix any leaks.

Adjusting Pressure, Pilot and Low Fire

- 1 All settings are set to operate at nominal pressure (see data plate). Test points to measure inlet and outlet pressure are located on gas valve. Unscrew brass screw on test point pressure nipples and attach manometer and read pressures with unit running. Adjust pressure to data plate requirements.
- 2 Check low fire if adjusted correctly.
- 3 Note: Failure to set pressures correctly will void warranty on the unit.

Lighting Instructions

Natural Draft Electronic Ignition Fireplaces are provided with 240volt electronic ignition systems.

An on/off wall switch is supplied and fitted with unit. The fireplace is switched on from wall switch. Power is then sent to valve to light pilot and main burner will then ignite from pilot.

Burner is turned off by turning off wall switch. System does not have a high low burner switch.

Laying the fire – Broken Glass & Logs

- Evenly spread the supplied Broken glass media into the burner tray. The media should be evenly spread level with the top edge of the burner tray.
- Unpack the optional logs and lay a row of logs over the Broken Glass media and around the burner tray as per the instructions.
- Leave spaces at the edges to allow free flow of gas.
- Experience will enable you to obtain a pleasing appearance with suitable heat output, but please bear in mind that it is important to maintain the general pattern described above and indicated in illustrations.

SEE PAGE 14-16 FOR MORE INFORMATION ON LOGS DIAGRAMS

Installation Instructions Phoenix Horizon Three Sided

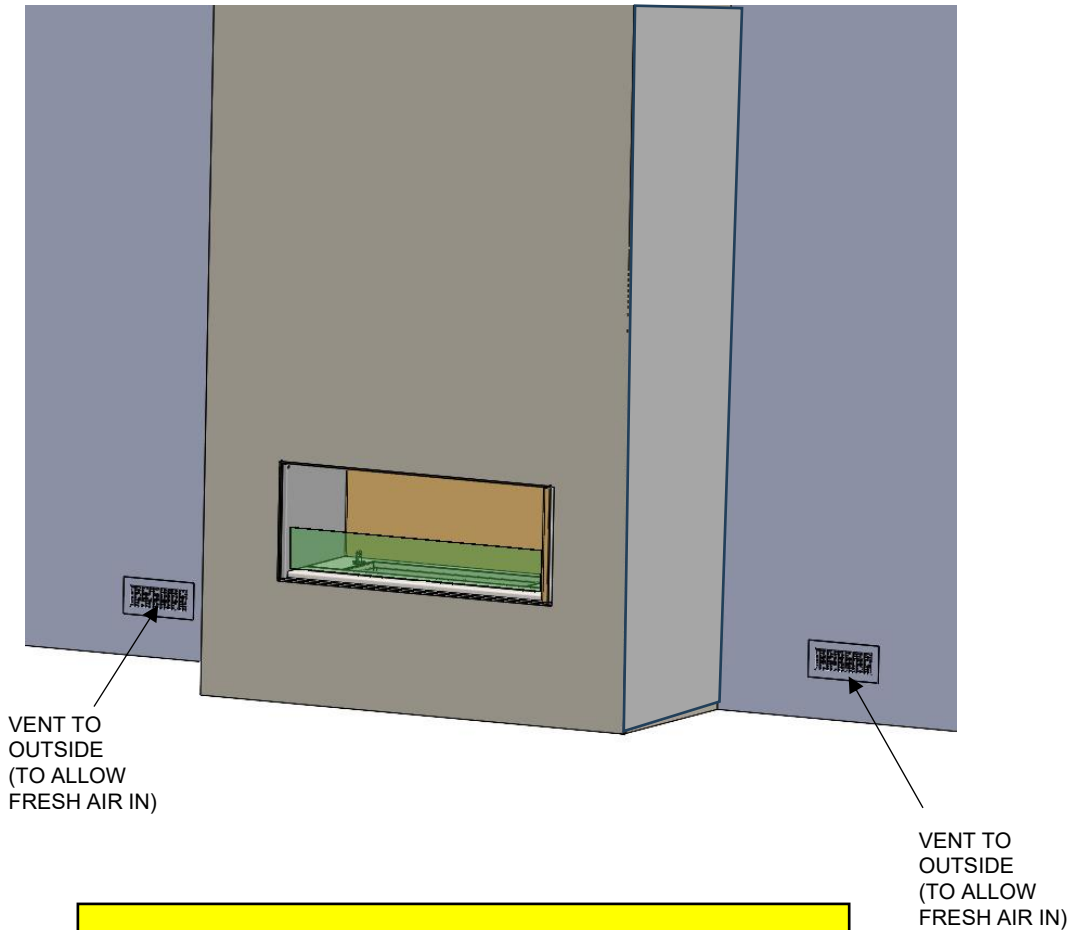

NOTE: AIR VENTS TO THE OUTSIDE IS REQUIRED TO LET FRESH AIR INTO THE CHASE.
VENT OPENING APPROXIMATELY 40,000 SQ.MM

Ventilation Requirements:

Rooms with gas open fireplaces require as per clause 6.10.9.5 in AS/NZS5601.1:2013, one or more ventilation openings with a combined free ventilation area of not less than the equivalent cross section area of the flue cowl shall be provided for each decorative flame effect fire, and calculations based on clause 6.4.4

Installation Instructions Phoenix Horizon Three Sided

VENTILATION FOR GRAVITY VENT OF OPEN GAS FIREPLACES THROUGH THE SLAB

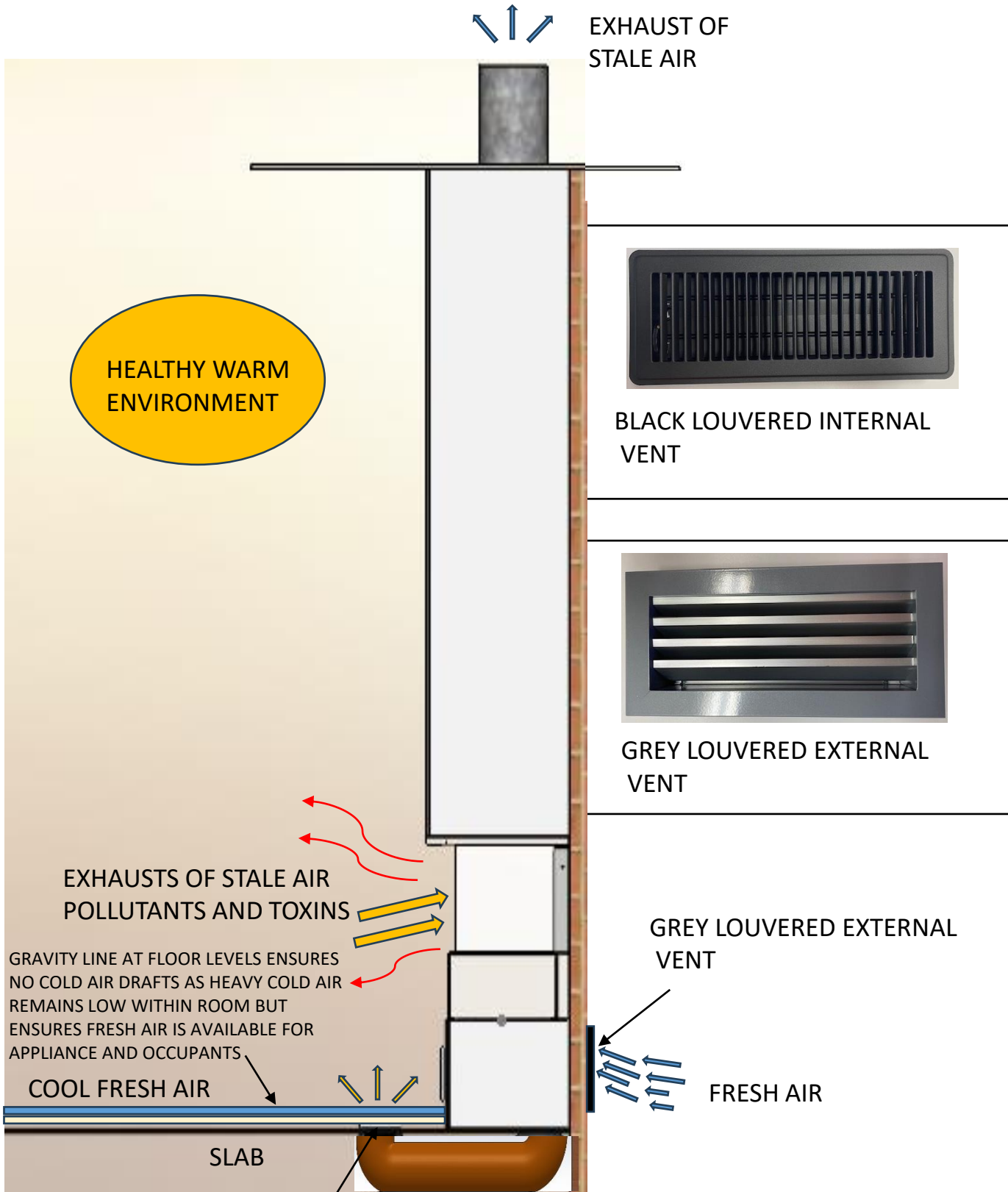

BLACK LOUVERED INTERNAL VENT

Horizon Phoenix Burner – Media Placement Instructions

Step 1: Install Black Break Glass Media

- Evenly place the **black break glass media** within the **burner media tray**, ensuring it is **level with the top edge of the tray**.
- **Note 1:** As an optional enhancement, **additional black glass media may be placed around the outside of the burner tray**, particularly when used in combination with the **log set**, for a more immersive visual effect.

Step 2: Install Log Set

- Place the **numbered ceramic logs** in sequential order, starting from the **right-hand side of the burner front**, continuing along the **left side**, and then finishing at the **rear of the burner**, following the placement guide illustrated in the reference images provided.





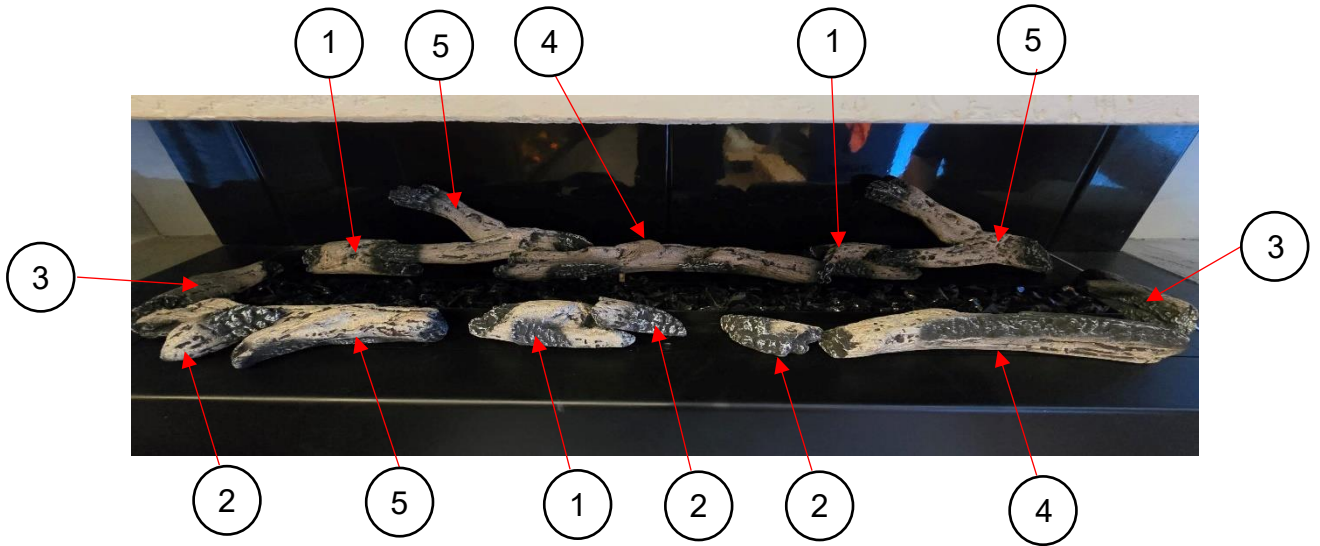

Important Notes:

- **Note 1.2:** Ensure that **no logs obstruct, cover, or impede** the flame path of the burner at any point.
- Logs should sit **securely and naturally** within the designated areas on or around the burner tray, with **no direct contact over burner ports**.

Installation Instructions Phoenix Horizon Three Sided

Horizon 1100 – Ceramic Log Set



<p>1</p> 		<p>2</p> 	
<p>3</p> 		<p>4</p> 	
<p>5</p> 		<p>6</p> 	



NOTE: THE MEDIA AND LOG SETS SHOWN CONTAINS:
 - 2 BAGS OF BLACK GLASS MEDIA
 - 1 BOX OF LOG SETS

Installation Instructions Phoenix Horizon Three Sided





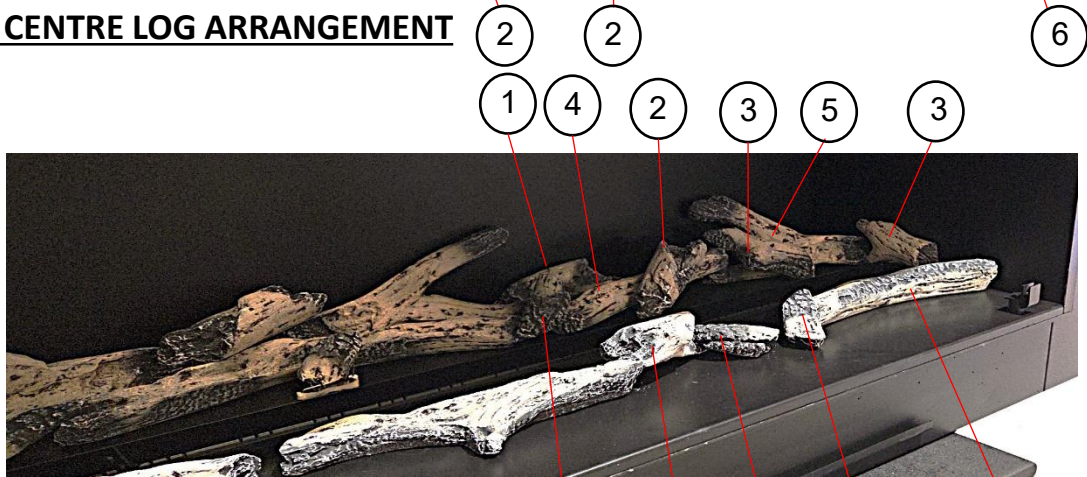

Horizon 1500 – Ceramic Log Set



LEFT TO CENTRE LOG ARRANGEMENT



CENTRE TO RIGHT LOG ARRANGEMENT





<p>1</p> 		<p>2</p> 	
<p>3</p> 		<p>4</p> 	
<p>5</p> 		<p>6</p> 	

NOTE: THE MEDIA AND LOG SETS SHOWN CONTAINS:
 - 4 BAGS OF BLACK GLASS MEDIA
 - 2 BOXES OF LOG SETS

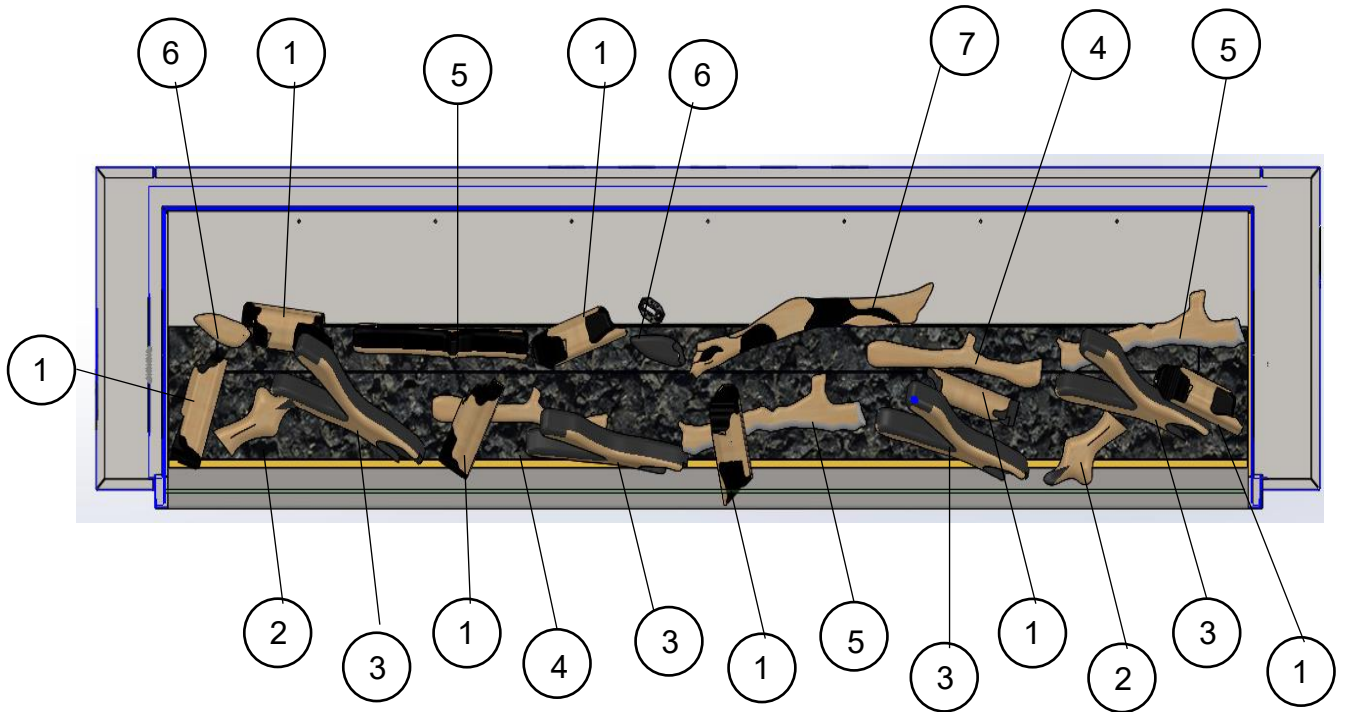
Installation Instructions Phoenix Horizon Three Sided

Horizon 2000 – Ceramic Log Set

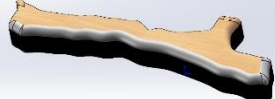
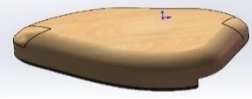
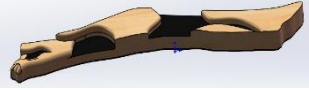

1		2	
3		4	
5		6	
7		8	

NOTE: THE MEDIA AND LOG SETS SHOWN CONTAINS:
 - 6 BAGS OF BLACK GLASS MEDIA
 - 2 BOXES OF LOG SETS

Installation Instructions Phoenix Horizon Three Sided

Commissioning Procedure

Installed correctly the burner should not emit any fumes into the room. The following procedure should be undertaken to test that the unit is operating correctly.

- 1 After unit has been operating for a short period a smoke match, smoke tube, carbon dioxide analyser or similar should be directed at the top opening of the unit.
- 2 This procedure should be undertaken with the following conditions in the room:
 - Open or closed windows
 - Operation of extraction/exhaust fans, range hoods etc.
 - Operation of other gas appliances
 - Operation of optional appliance fan at any speed.
- 3 Should any spillage be detected the cause must be rectified before allowing commissioning of unit.
4. Please test appliance operation before leaving.

User Instructions

1. **WARNING NOTE:** Properly installed and operated this appliance will not leak gases. Persistent fume emission must not be tolerated. If fume emission does exist, then the following immediate action should be taken.
 - A Open doors and windows to ventilate room.
 - B Turn the fire off.
 - C Check for flue blockage and clear if necessary.
 - D Do not attempt to relight the burner until the cause of the emission has been identified and rectified. Should assistance be required contact nearest agent.
- E The gas burner is designed to work in a Kemlan Horizon electronic power flue ignition system. Working correctly there will be no spillage. Unit should cut out if not enough draw to ensure proper functioning.
- 2 Initially the Kemlan coal fire may burn with a slightly blue flame. After approximately 20 minutes the fire will settle down and burn with a yellow flame.
- 3 As with all gas fires your gas coal/pebble or log fire should be regularly serviced. We recommend once each year. Service information for an authorised person to follow has been set out in attached leaflet.
- 4 **PLEASE NOTE:** Only logs provided by Kemlan should be used with this appliance.
- 5 **DO NOT** place articles on or against this appliance.
 - DO NOT** use or store flammable materials near this appliance.
 - DO NOT** spray aerosols in the vicinity of this appliance whilst it is in operation.
 - DO NOT** modify this appliance.Primarily a decorative appliance not certified as a space heater.
- 6 The appliance is a live fuel effect product designed to operate with luminous flames and may exhibit slight carbon deposition.
7. The guard is fitted to this appliance to reduce the risk of fire or injury from burns and no part of it should be permanently removed.

SERVICE - WARNING: ONLY TO BE SERVICED BY AN AUTHORISED PERSON

IMPORTANT: THIS APPLIANCE REQUIRES FRESH AIR TO OPERATE SAFELY. THE ROOM WHERE THIS APPLIANCE IS INSTALLED MUST HAVE PERMANENT VENTILATION FROM OUTDOORS, THIS VENTILATION MUST NOT BE MODIFIED.

VALVE AND TECHRITE MODULE ACCESS INSTRUCTION

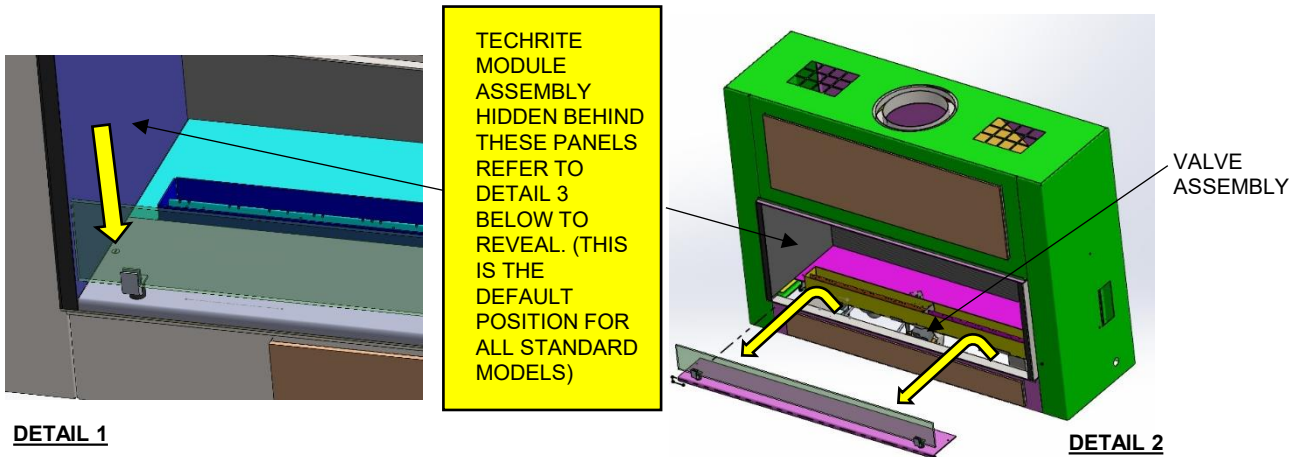

1. REMOVE BOTH SIDE SCREWS ON THE FRONT BURNER TRAY AS INDICATED
 (NOTE: IT IS ALSO OPTIONAL TO REMOVE THE FRONT GLASS BUMPER. THIS CAN BE ACHIEVED BY UNFASTENING THE GRUB SCREW BEHIND THE GLASS PANE ON BOTH SIDES.)
2. SLIDE THE FRONT BURNER TRAY ASSEMBLY FORWARD, THEN TILT THE FRONT EDGE ONLY UPWARDS, REMOVE THE WHOLE ASSEMBLY AWAY IF REQUIRED. THE INNER PARTS OF THE VALVE ASSEMBLY WILL BE ACCESSIBLE FOR ADJUSTMENTS, MAINTENANCE, OR REPAIRS.

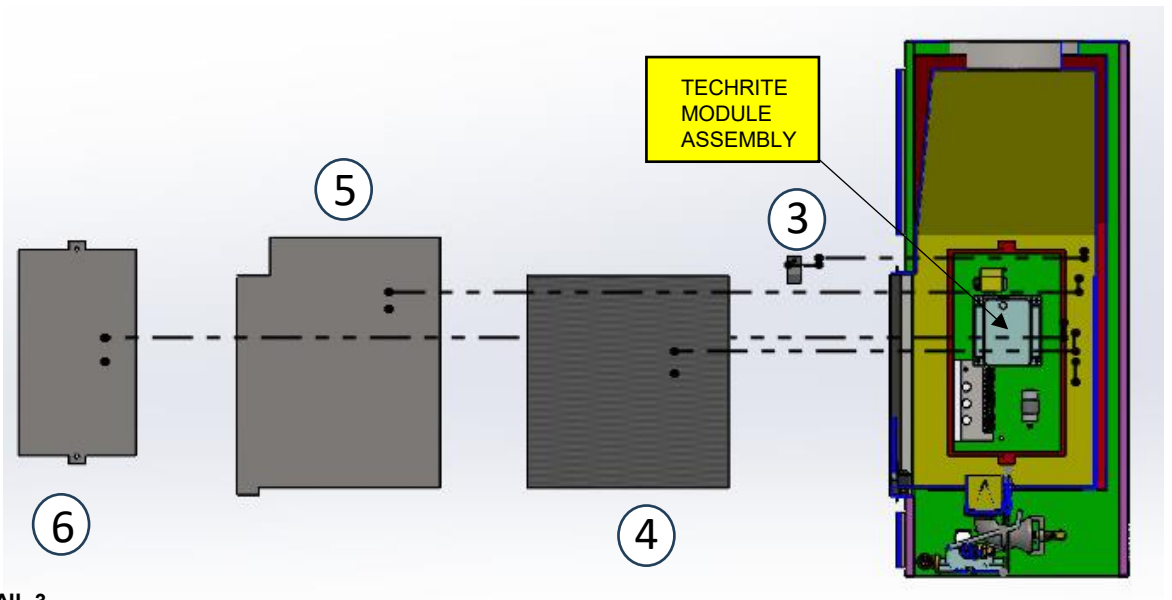

3. UNFASTEN THE SELF-TAPPING SCREW AND REMOVE THE GLASS BRACKET. MAKE SURE THE GLASS DOES NOT FALL OVER AND BREAK.
4. PULL THE GLASS AWAY FROM THE APPLIANCE AND KEEP IN A SAFE PLACE.
5. REMOVE THE HEAT GUARD PANEL AWAY FROM THE APPLIANCE.
6. REMOVE THE 2 SCREWS HOLDING THE DOOR AND MOVE THE DOOR AWAY. THIS WILL EXPOSE THE TECHRITE MODULE READY FOR ADJUSTMENTS MAINTENANCE OR REPAIRS

Installation Instructions Phoenix Horizon Three Sided



WIRING CONNECTIONS

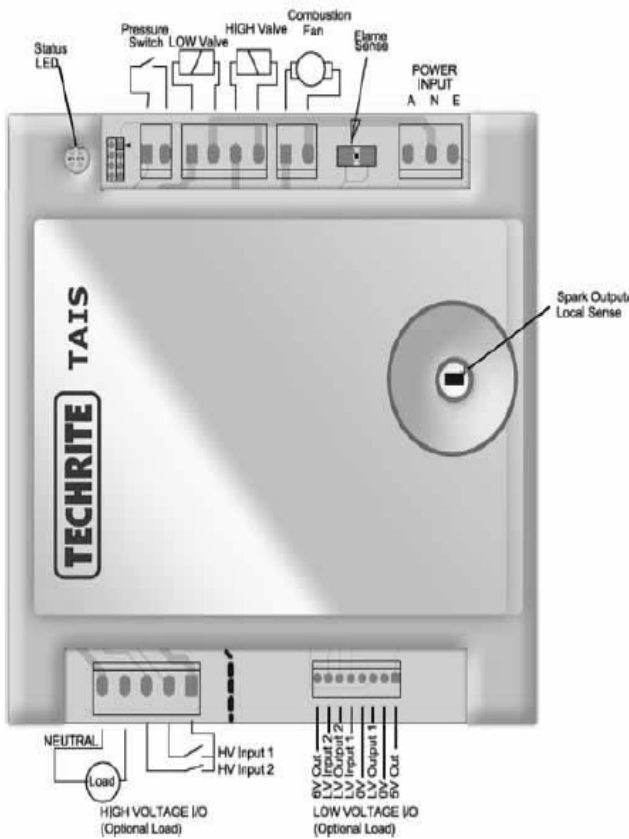

Installation Instructions Phoenix Horizon Three Sided



TAIS IGNITION MODULE

COMMISSIONING NOTES

	The controller and monitoring devices should be switched off.
	Check all the terminals are properly connected and tightened.
	Switching points of gas pressure switch – Normally Open contacts.

INCLUDE COMMISSIONING NOTES FROM THE TEST PROCEDURE

LED FLASH CODES

	The flashing Red LED light indicates the module state.
	The flashing Green LED light indicates the ignition module is sensing the flame.

TROUBLE SHOOTING GUIDE

	Warning: This is a 240VAC module. All connections to the module are 240V (except ignition cable and flame sense). Ensure power is switched off before checking any connection or replacing any components.
	The ignition unit is polarity sensitive. If the active and neutral cables are not wired correctly, the unit will not sense a flame, the green LED will not come on. The heater will light but will turn off almost immediately as a result.
	Before carrying out repairs, turn off the power, visually inspect all cables and connections for damage or corrosion
	Be certain to turn off the power before disconnecting or checking supply switch.

If a fault occurs, the sequence of LED flashes giving the description about the nature of the fault. It makes troubleshooting much easier. Some of the more common codes are listed below.

Installation Instructions Phoenix Horizon Three Sided

LED Flash code (Long Flashes – Short Flashes)	Description	Possible Causes
		The following codes may occur during startup
0-2	Normal Operation – Start Up Delay	-
1-0	Normal Operation	Appliances running correctly (Green LED will be ON)
1-1	Flame failure detected	Loss of Flame. Check Flame sensor and spark electrode. Check gas Supply.
1-2	Waiting for main pressure switch	<ul style="list-style-type: none"> • Pressure switch is closed on start-up/ Check terminal Connection. • fan is not starting/ Check connection on Fan terminal. • producing enough pressure for pressure switch to close/ Check whether fan is running at higher speed.
1-3	Waiting for second pressure switch	Same reasons as above but for second pressure switch (if used/available)
1-4	Waiting for flame sense to go OFF	A flame is detected on start-up. Check flame sense circuit.
1-5	Purge operation in progress (pre purge, inter purge or post purge)	Waiting for any purge times to expire.
1-6	Waiting for Vent Switch contacts before continuing	Waiting for vent switch contacts to be open at start-up or close after vent switch time has expired. Check vent motor is being powered and is moving. Check vent switch.
1-7	Waiting for Hot Surface Ignitor pre-heat timer to expire	Waiting for HSI heat up time to expire.
1-8	Waiting for fan tachno feedback signal to be within acceptance window (module option)	Fault in tachno or tachno feedback circuit. Check tachno circuit connection.
The following codes are invoked as a result of a lockout condition		
2-1	Maximum retries exceeded	<ul style="list-style-type: none"> • Module has tried for ignition but failed, check module is sparking at the spark electrode. • Check gas supply. • Check gas valve is opening.
2-2	Lockout due to flame failure	<ul style="list-style-type: none"> • Module has been running but flame has gone out. • Check gas supply • Check gas valve. • Check flame sense circuit.

Installation Instructions Phoenix Horizon Three Sided

TAIS IGNITION MODULE

LED Flash code (Long Flashes – Short Flashes)	Description	Possible Causes
2-3,2-4,2-5	Hardware failure on module output(s). Possible hardware failure in module	<ul style="list-style-type: none"> • Hardware failure. Check gas valve coil. If a rectifier plug is used on the valve (E.g. EBM plug), a fault in this plug will cause this fault. • Also possible module fault.
2-6	Hardware failure on flame sensing circuit.	Check sense electrode in not touching the ground or the burner.
2-7	Hardware failure in module	Replace module
2-8	Combustion Fan timeout (where fitted)	<ul style="list-style-type: none"> • Combustion fan has run for maximum allowable time without closing the pressure switch. • Check fan has power and is running. • Check pressure switch connections. • Clear dust from fan and tubes feeding pressure switch.
2-9	Vent Switch lockout (where fitted)	Module has locked out after vent switch did not close after maximum allowable time (normally 85 seconds).
The following codes are invoked as a result of a lockout condition / hardware fault		
3-1	Lockout due to main pressure switch opening (where fitted)	<ul style="list-style-type: none"> • Main pressure switch has opened during operation. • Check pressure switch and fan. • Check flue/pressure switch is not affected by wind gusts.
3-2	Lockout due to second pressure switch opening (where fitted)	As above but for second pressure switch (if used/available).
3-3	Lockout due to fan tachometer feedback signal failing (where fitted)	No feedback from tachometer. Check tachometer circuit.
3-4	Lockout due to internal fault (software error).	Module fault. Replace module
3-5	Lockout due to internal fault (EEPROM error)	
3-6	Lockout due to internal fault (microcontroller communications error)	

WARRANTY FOR HORIZON MODELS

1. Provided the appliance has been correctly installed according to instructions, Kemlan guarantee the cost of replacing parts and the labour in connection therewith for a period of 12 months from the date of installation.
 - 1a. 10 years on the structural integrity of the firebox.
 - 1b. 12 months on power Flue motor and electrical components.

2. THIS WARRANTY DOES NOT COVER –

- 2.1 Failure to comply with manufacturer’s operation instructions.
- 2.2 Normal wear and tear or damage caused by incorrect installation.
- 2.3 Any form of rust and/or corrosion to the painted finish of the heater.
- 2.4 Damage caused by water ingress.
- 2.5 Cost of removal of defective heater or re-installation of replacement heater.
- 2.6 Failure to use fireplace components supplied by Kemlan Industries Pty Ltd.
- 2.7 Cost of inspection for damaged heater.

3. CLAIMS –

- 3.1 Should any defects occur, contact the Kemlan distributor from whom you purchased the heater.
 - 3.2 Under this warranty the defective parts will be repaired or replaced by Kemlan’s option, free of charge.
4. The fireplace installation must comply with the relevant local statutes, ordinances, regulations and by-laws.

PLEASE COMPLETE AND RETAIN THIS SECTION FOR YOUR RECORDS

Purchased from:
Address:
Date of Purchase: