



Jetmaster

EST 1950

Installation instructions
Jetmaster Mark 3 Gas Coal



Installation instructions Jetmaster Mark 3 Gas Coal

Jetmaster gas coal burners are fuel effect appliances intended for use in a fireplace suitable for the burning of wood. It is recommended that the Jetmaster gas log be placed in a properly installed Jetmaster Convectector firebox in order to ensure an adequate draught and greater efficiency. The Jetmaster open fire is an approved open fire to burn wood. The following size fireboxes are available for the Type I Burner to be inserted into. The firebox can be installed into an existing fireplace subject to the chimney being the appropriate size and in sound condition. The firebox can also be installed from new with a gather and a flue.

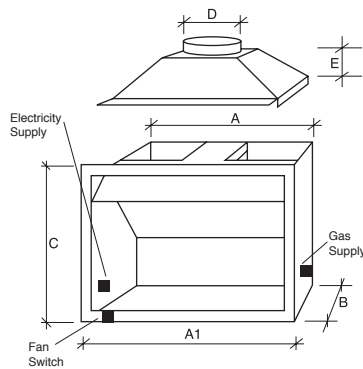

(DIMENSIONS IN MILLIMETERS)

	A	A1	B	C	D	E
600	670	700	350	650	200	200
600 LOW	670	700	350	600	200	200
700SH	770	800	350	650	200	200
700SH LOW	770	800	350	600	200	200
700D	770	800	400	700	225	200
850	920	950	450	750	250	220
850 LOW	920	950	450	700	250	220

IMPORTANT: Installation of this appliance should only be carried out by an authorised person in accordance with the manufacturers instructions. All relevant codes and regulations laid down by the gas supply authorities, uniform building regulations and the requirements of local municipal authorities must be observed.

Model Type I: Decorative Gas Coal Mark 3 Fire

600 GAS COAL MARK 3:

Width 590mm Height 135mm Depth 217mm

700 GAS COAL MARK 3:

Width 690mm Height 135mm Depth 217mm

DATA PLATE: Refer to data plate for information in respect of gas pressure and consumption. The data plate is attached to the base of the unit on a chain.

Location Requirements

1. The fireplace construction must be non-combustible and in accordance with the current Building Regulations for chimney and fireplace intended for solid fuel use.
 2. The flue and/or chimney should be tested and proven to have an adequate updraft which shall be sufficient to remove all waste products of combustion. A minimum cross-sectional area of 40,000 sq mm is required with a minimum chimney flue height of 3.6 meters. The installer must satisfy himself that the fireplace is functioning properly and a smoke test is recommended. When using a Jetmaster firebox the appropriate diameter flue for the model fireplace should be used.
 3. The appliance must comply with AG601 Gas Installation Code.
 4. In cases where a twin walled metal flue is used and provided such flue shall comply with the clearances specified in AS2918 or manufacturers instructions in respect of clearance to combustibles.
 5. In cases where a metal is used, such flue shall comply with the standards relating to grade, quality and thickness as are current.
 6. An approved flue cowl with a minimum cross-sections of 40,000sq mm shall be affixed to the top of the flue or chimney.
 7. The installer must remove or fix in an open position any damper which may be affixed to or contained in any fireplace.
 8. It should be noted that the Code AS2286 (space heating appliances-secondary guards) requires a dress guard to be affixed to the appliance or fireplace.
 9. Ventilation. An opening to outside with a minimum free ventilation area of 400sq cm shall be provided for each decorative gas log fire.
- NOTE:** The chimney in which the appliance is installed is not to be considered as a ventilation opening.
10. The appliance shall be installed into a fireplace with a minimum opening of 600mm width and 217mm depth and shall be no greater than 10650mm width and 400mm depth.
 11. Combustible materials to be no closer than 100mm either side of fireplace opening and no closer than 150mm above the opening. The firebox should have a non combustible hearth in front of the firebox.

Installation instructions Jetmaster Mark 3 Gas Coal

Installation: Fitting the Gas Grate

1. Check unit is suitable for intended gas supply.
2. The position of the gas control and inlet is on the right hand side. A regulator is supplied when fitting to natural gas. A gas cock must be fitted prior to the burner to enable the unit to be removed for servicing. (It is recommended that the fireplace and chimney be cleaned prior to fitting the gas unit).
3. In an existing fireplace or Jetmaster firebox (if being used), drill a 15mm hole through the right hand side of the fireplace (as you face it) at a point of 85mm from the base and 85mm from the front face.
4. Cut and debur both ends of pipe. Fit the end to the gas supply point and turn on for approximately 5 seconds to clear the pipe of any dirt or grit. Fit the other end to the gasunit.
5. The regulator supplied and attached to the appliance is for natural gas.
6. Turn on the gas and check all connections for leaks using soapy water for approved method. Fix any leaks.
7. This appliance is approved for use only on Natural Gas and must not be converted to any other gas.
8. This appliance is approved for use only on Natural Gas and must not be converted to any other gas.

Adjusting Pressure, Pilot and Low Fire

1. All settings are set to operate at appropriate pressures (see data plate). Test point is located on gas valve.
2. Check low fire if adjusted correctly.
3. The pressure can be measured on the gas valve and the regulator and be adjusted by turning the screws on the gas valve located either side of the test pressure points. See below (A) and (B)

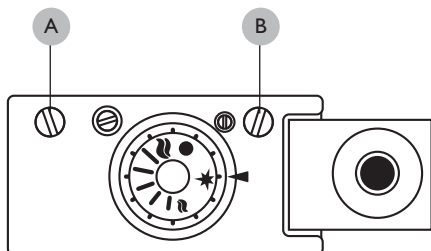

Lighting Instructions

PILOT FLAME IGNITION

(FIGURE 1)

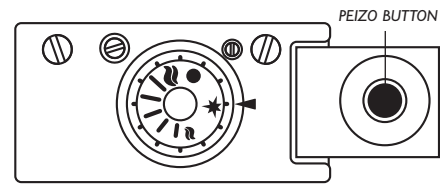

1. Depress and turn control knob to the PILOT ★ position.
2. Depress the control knob fully and at the same time light pilot by depressing piezo button to create spark to pilot. Maintain pilot by continuing to hold button in for 20 seconds. Release button and check that pilot stays lit. If it goes out repeat ignition procedure.

MAIN BURNER IGNITION

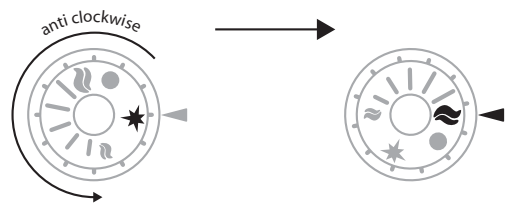

1. Depress and turn control knob anti-clockwise from PILOT position to the ON position. When the automatic solenoid valve is energised, gas passage to main burner is opened. Once burner is on, knob can be turned to low FIRE position to obtain minimum gas flow.

TURNING MAIN BURNER OFF WITH PILOT BURNING

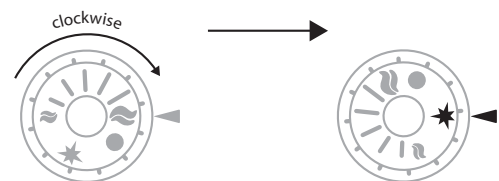

1. Depress and turn control knob clockwise from on position to PILOT position.

TO TURN PILOT AND MAIN BURNER OFF

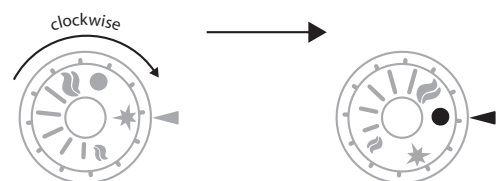

1. Depress and turn control knob clockwise from PILOT position to OFF position.

Installation instructions Jetmaster Mark 3 Gas Coal

Laying the fire

- Unpack the coals contained in a clear plastic bag and lay a row of coals on the vermiculite along the back of the burner tray leaving approximately 12-15mm between them.
- Leave spaces at the edges to allow free flow of gas.
- Place a further row of coals directly in front of the first row but staggered so that the second row of coals are behind the gaps of the first row leaving approximately 12-15mm between the rows of each coal.
- Lay further rows of staggered coals depending on the size of the basket grate.
- Once the bottom layer is completed, build up 2-3 tiers of coals in a honeycomb pattern to form an elongated pyramid.

- Lay the coals so that some irregularity to the pile through which the flames may lick, is created. Your aim is to build “windows” into the fire through which the radiant effect may show but at the same time, not leaving such large gaps between the coals that excessive air may enter and “damp down” the red glow.
- After the fire has been alight for 15 minutes, you may wish to add the odd coal or even relay the fire completely. Allow to cool before touching the coals.
- Experience will enable you to obtain a pleasing appearance with suitable heat output, but please bear in mind that it is important to maintain the general pattern described above and included in illustrations.

Note: Use coals supplied by the manufacturer as other coals may effect combustion performance.

Model 600 Mark 3



FIRST LAYER 24 COALS



SECOND LAYER 14 COALS

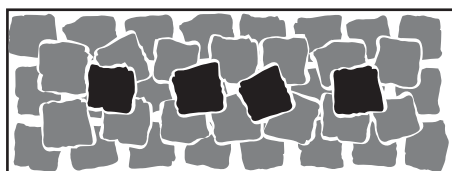

THIRD LAYER 4 COALS

Model 700 Mark 3



FIRST LAYER 24 COALS

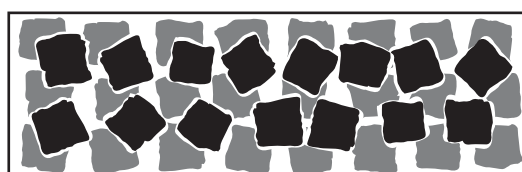

SECOND LAYER 15 COALS

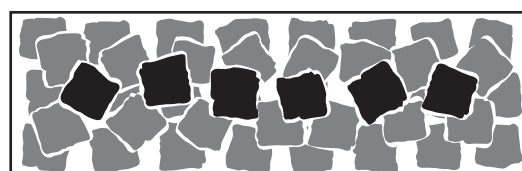

THIRD LAYER 6 COALS

Installation instructions Jetmaster Mark 3 Gas Coal

Commissioning Procedure

Installed correctly the burner should not emit any fumes into the room. The following procedure should be undertaken to test that the unit is operating correctly.

1. After unit has been operating for a short period a smoke match, smoke tube, carbon dioxide analyser or similar should be directed at the top opening of the unit.
2. This procedure should be undertaken with the following conditions in the room:
 - Open or closed windows
 - Operation of extraction/exhaust fans, range hoods etc
 - Operation of other gas appliances
 - Operation of optional appliance fan at any speed.
3. Should any spillage be detected the cause must be rectified before allowing commissioning of unit.

User Instructions

1. **WARNING NOTE:** Properly installed and operated this appliance will not leak gases. Persistent fume emission must not be tolerated. If fume emission does exist, then the following immediate action should be taken.
 - A. Open doors and windows to ventilate room.
 - B. Turn the fire off.
 - C. Check for flue blockage and clear if necessary.
 - D. Do not attempt to relight the burner until the cause of the emission has been identified and rectified. Should assistance or advice be required contact nearest agent or Jetmaster.
 - E. The gas grate is recommended for use in a Jetmaster firebox which has been designed to ensure a proper draw and to eliminate emission spillage.
2. Initially the Jetmaster coal fire may burn with a slightly blue flame. After approximately 20 minutes the fire will settle down and burn with a yellow flame.
3. As with all gas appliances your gas coal fire should be regularly serviced. We recommend once each year. Contact your nearest Jetmaster authorised agent to provide service. The routine for an authorised person to follow has been set out in an attached leaflet.
4. **PLEASE NOTE:** Only coals provided by Jetmaster should be used with this appliance.

5. **DO NOT** place articles on or against this appliance.
DO NOT use or store flammable materials near this appliance.
DO NOT spray aerosols in the vicinity of this appliance whilst it is in operation.
Primarily a decorative appliance not certified as a space heater.
6. The appliance is a live fuel effect product designed to operate with luminous flames and may exhibit slight carbon deposition.

Warranty

Provided the appliance has been correctly installed according to instructions, Jetmaster guarantee the cost of replacing parts and the labour in connection therewith for a period of 12 months from the date of installation. Should the appliance be subject to a service contract the replacement of the parts and the service involved in such replacement shall be at no charge to the owner and the Warranty shall be extended to 3 years (provided of course the appliance had been continuously serviced by an approved Jetmaster agent).

