

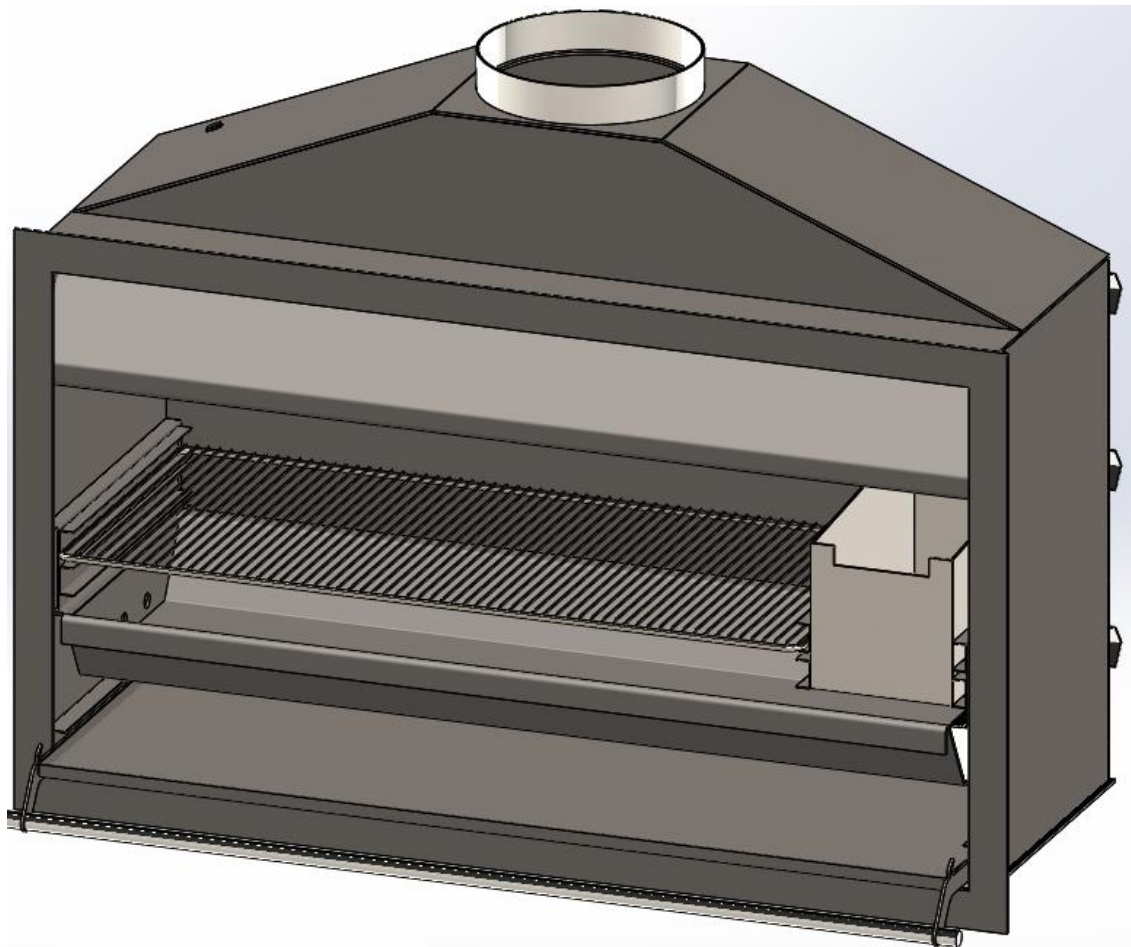

CONTRACTOR 1000 AND 1200



IMPORTANT:

INSTALLER, PLEASE LEAVE THESE INSTRUCTIONS WITH THE UNIT ON COMPLETION.

Head Office – 13 French Avenue, Brendale, Queensland 4500

Telephone – PH: (07) 3490 5500

Facsimile – FAX: (07) 3490 5520

Website: - www.jetmaster.com.au

Business hours: - Monday to Thursday 7:30am-4:00pm. Friday 7:30am-2:00pm

Email: - sales@jetmaster.com.au



CONTRACTOR 1000 AND 1200 DIMENSIONS

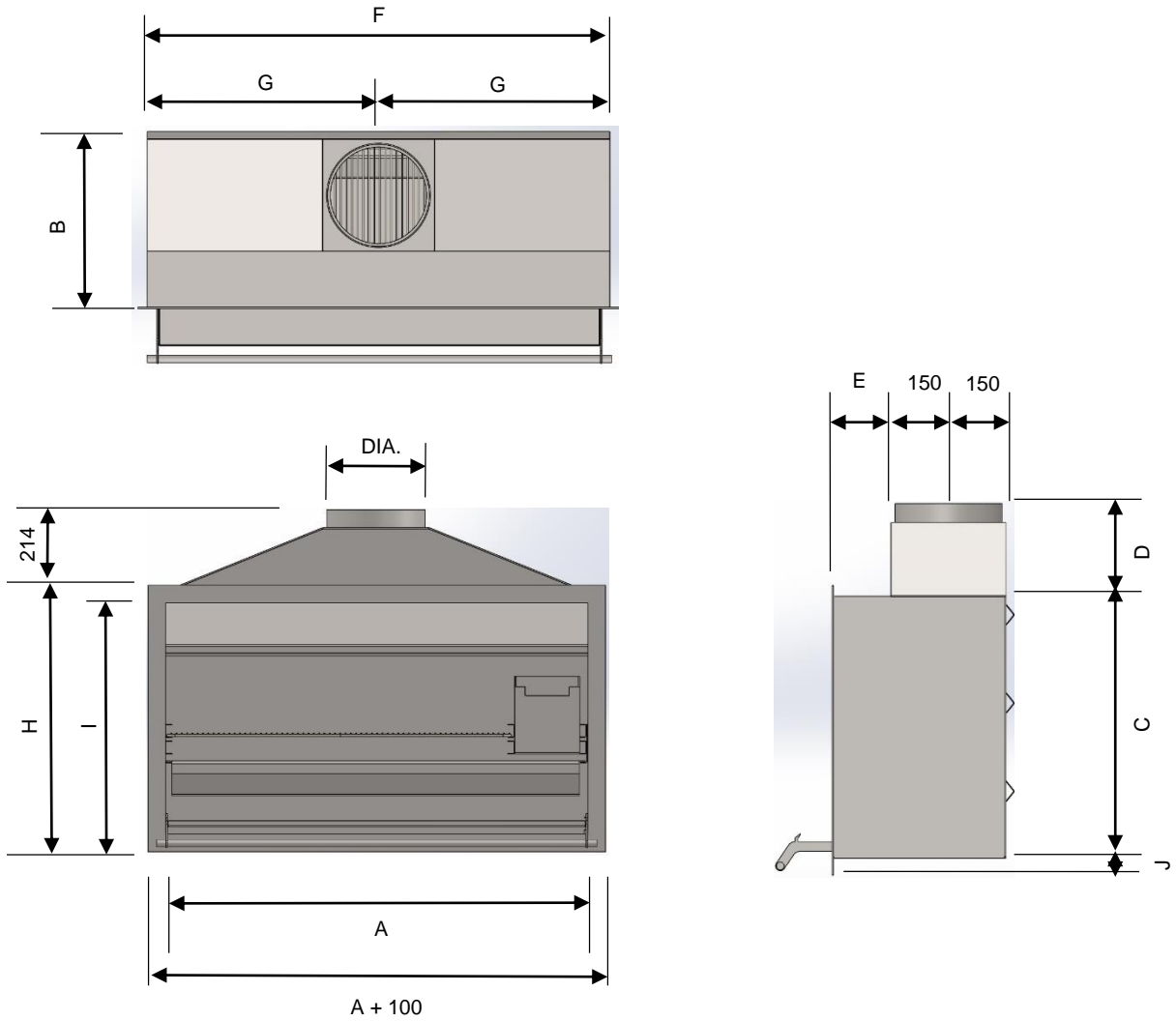

MODEL	MEASUREMENT										FLUE SIZE
	A	B	C	D	E	F	G	H	I	J	DIA.
1000	1000	480	710	240	150	1045	522.5	750	700	23	254
1200	1200	480	690	240	150	1245	622.5	755	705	44	279.4



CONTRACTOR 1000 AND 1200 LIGHT FITTING INSTRUCTION

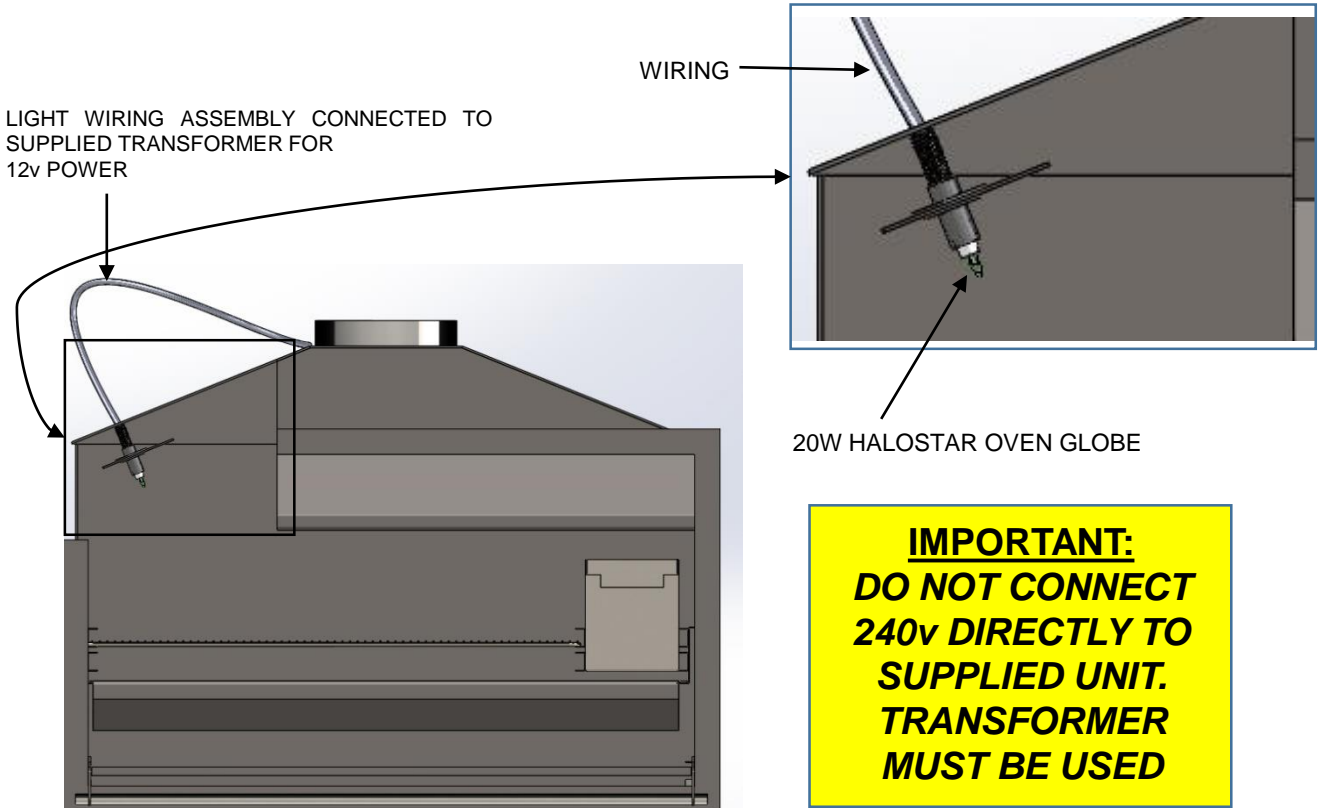

LIGHT ASSEMBLY KIT SUPPLIED:

1. 20W HALOSTAR OVEN GLOBE
2. WIRING
3. 12v a.c. OUTPUT TRANSFORMER

WIRING DIAGRAM

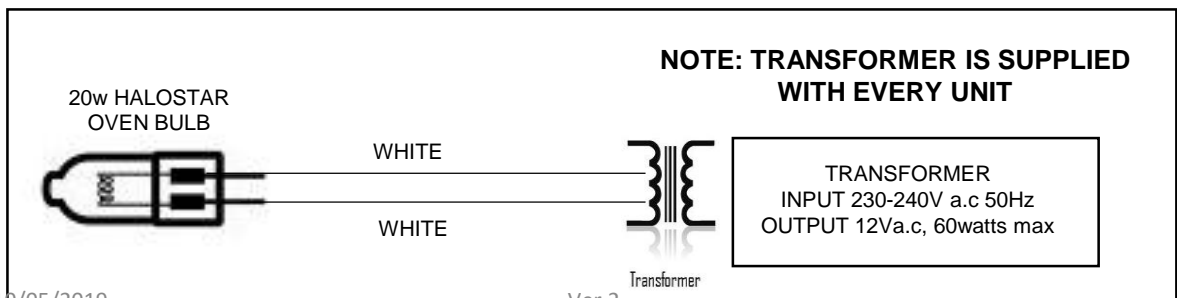



CONTRACTOR 1000 AND 1200 LIGHT FITTING INSTRUCTION

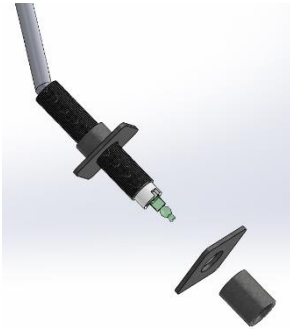

REMOVE ALL WASHERS AND NUT FROM THE WIRING. THEN ATTACH THE BULB TO THE LIGHT FITTING.

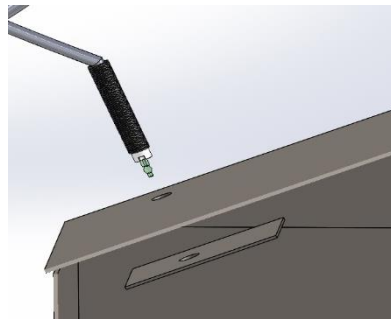

PUSH THE LIGHT FITTING THROUGH THE HOLE ON THE OUTER BOX AND INTO THE GAP BETWEEN THE PLATE AND OUTER BOX.

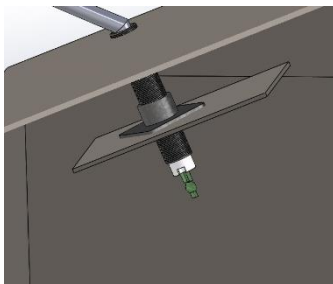

ATTACH THE SMALLER ROUND NUT AND ONE 50mm WASHER ONLY. PUSH THROUGH THE HOLE ON THE LIGHT PLATE ADJUST THE NUT AND WASHER PLACEMENT FOR BEST FIT.

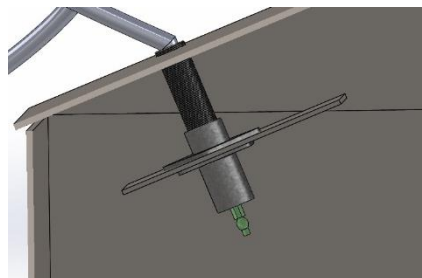

ATTACH ANOTHER 50mm WASHER. ON THE OTHER SIDE OF THE LIGHT PLATE AND USE THE LONGER NUT TO HOLD IN PLACE, THE END OF THE NUT SHOULD BE FLUSH WITH THE END OF THE LIGHT FITTING.

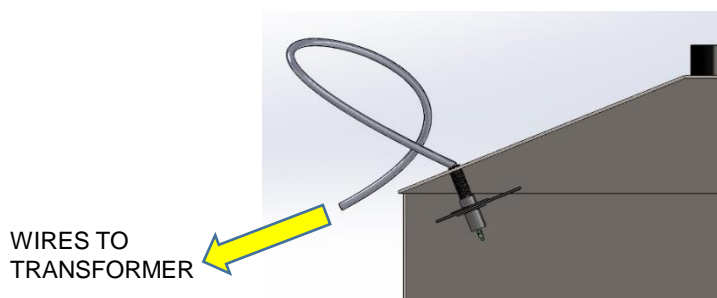

WIRES TO TRANSFORMER

CONNECT 2x WHITE WIRES ON THE WIRING TO THE TRANSFORMER AND THE LIGHT WILL BE READY FOR USE



CONTRACTOR 1000 AND 1200

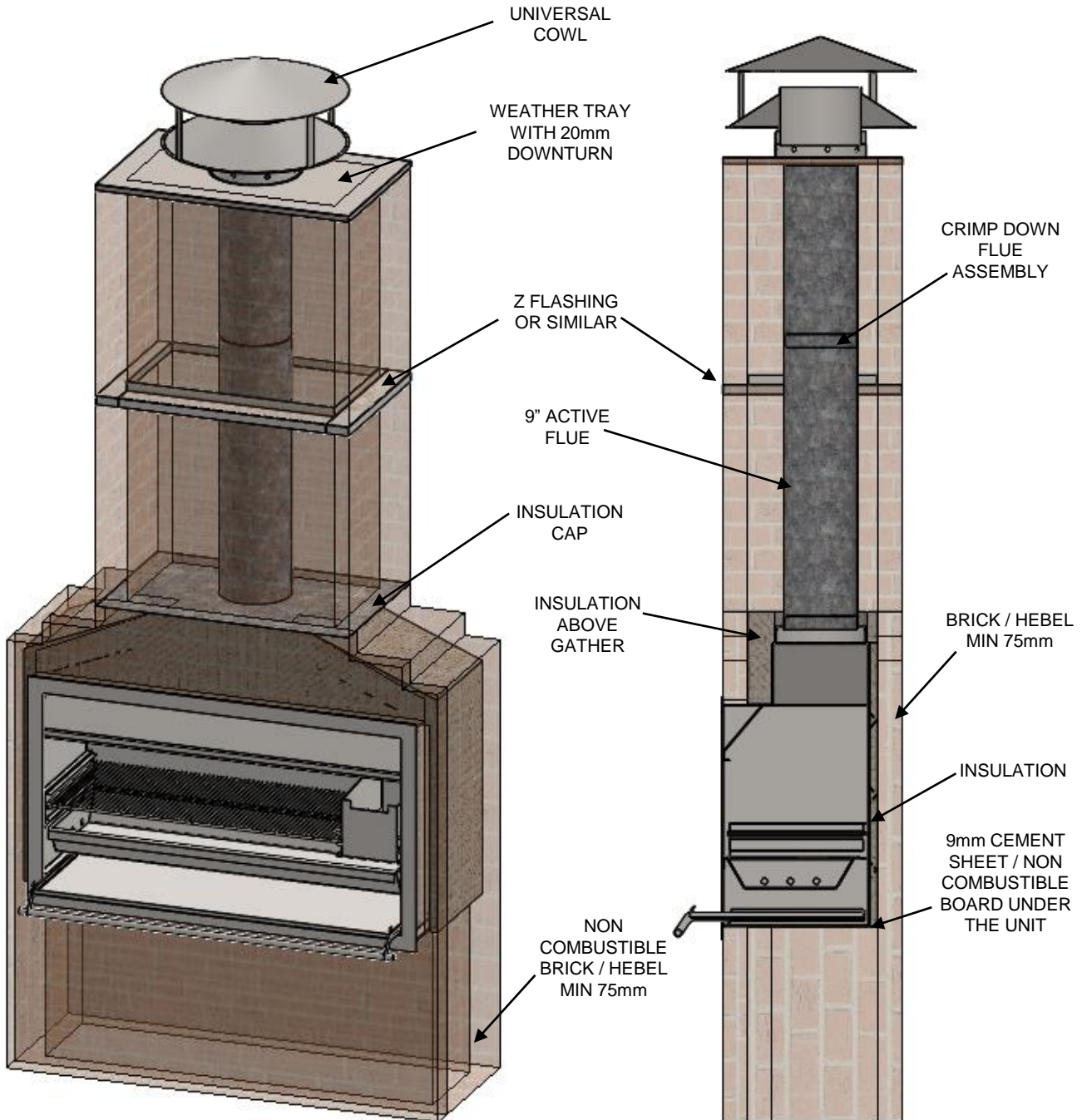



CONTRACTOR 1000 AND 1200

ALTERNATIVE BRICK CHIMNEY TERMINATION

SPLAYED RENDER TO
DISPERSE RAIN WATER
AWAY FROM TOP OF
FLUE

FIBRE CEMENT
COLLARS AROUND THE
FLUE

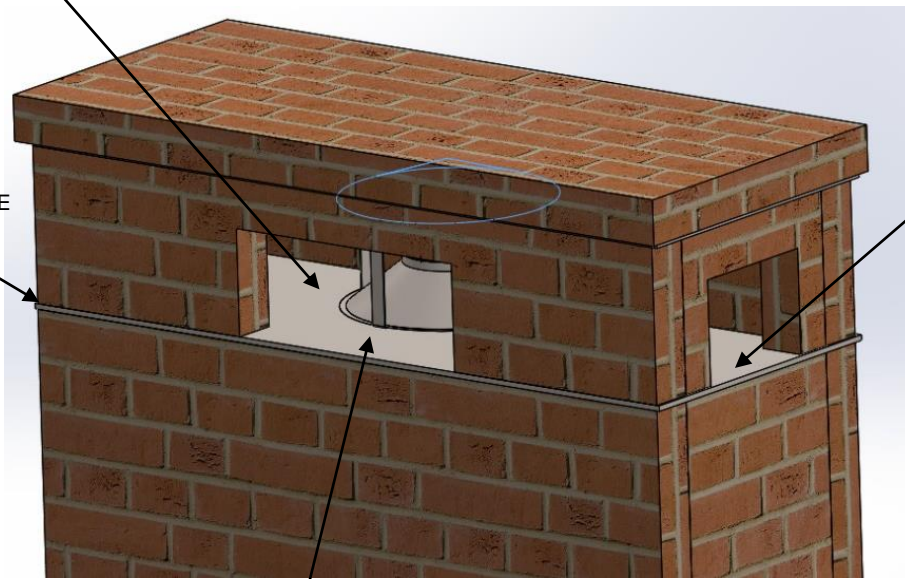

2 x 230mmx172mm
CHIMNEY OPENINGS
(MIN. SIZE)

2 x 230mmx172mm
CHIMNEY OPENINGS (MIN. SIZE)
NOTE: IF CHIMNEY IS MORE THAN
950mm WIDE ,THEN THE TWO OUTLETS
ONLY ARE QUITE PRACTICAL ON THE
LONG SIDE OF CHIMNEY – WIDTH OF
OUTLET TO BE WIDENED IN
ACCORDANCE WITH THE LENGTH OF
THE CHIMNEY